



Spring Based Methodology for Spring-back Compensation in Die Design

Shaghghi Moghaddam, A., Faculty of Mechanical Engineering, Takestan Islamic Azad University

E-mail: A.shaghghi@tiau.ac.ir

Abstract: In this investigation a new spring-back compensation strategy is developed for plane problems. A spring-based model of the deep drawn parts is defined according to the nodal configuration at the mid plane of the thickness. The idea of pure arc bending and pure stretching following the FE results for the blank, reference and spring-back meshes are applied to estimate the elastic-plastic behavior of each spring in the spring-based demonstration of the part. Approximating the amount of spring-back in the stamping process by defining a number of elastic-plastic torsion and tension springs in the nodal configuration, it is now possible to predict the compensated tool set in order to have the desired part after unloading. This method is demonstrated on two industrial parts in truck mixer industry. The fast convergence and accuracy of the proposed algorithm is verified by comparing the results to that of the DA method and experimental data.

Keywords: Spring-back compensation, Deep drawing, Torsion and tension springs, Spring demonstration

روش شناختی فنری برای جبران سازی برگشت فنری در طراحی قالب

علی شقاقی مقدم - استادیار گروه طراحی کاربردی، دانشکده مهندسی مکانیک، دانشگاه آزاد اسلامی واحد تاکستان

چکیده: در این تحقیق یک راهبرد جدید جبران سازی برگشت فنری برای مسائل سطحی توسعه داده می شود. یک مدل فنری برای نورد عمیق قطعات بر مبنای تعیین گره در سطح میانی ضخامت تعریف می شود. ایده کمان خمش خالص و کشش خالص با کاربرد نتایج المان های محدود برای مش های برگشت فنری مبنا و خالی جهت تخمین رفتار ارتجاعی و دایمی برای هر فنر بر مبنای جبران سازی برگشت فنری قطعات با تقریب مقدار برگشت فنری در فرآیند حکاکی با تعیین تعدادی از فنرهای کششی و پیچشی در حد ارتجاعی - دائمی در تعیین گره ها ممکن است برای پیش بینی تنظیم ابزار بمنظور حصول به یک محصول مناسب پس از باربرداری می باشد. این روش بر روی دو قطعه صنعتی در صنعت دستگاه مخلوط کن بکار گرفته شد. همگرایی سریع و دقت الگوریتم پیشنهادی با مقایسه نتایج و نتایج حاصل از روش DA و نتایج تجربی ارزیابی شد.

واژه های کلیدی: برگشت فنری، نورد عمیق، طراحی قالب و رفتار ارتجاعی - پلاستیک.

1. Introduction

Deep drawing is one of the most common manufacturing processes especially in automobile and aerospace industries [1]. Deep drawn products are mostly parts of a large assembly so that it is crucial that they be manufactured in closed tolerances. The problem that arises in deep drawing process is the deviation taken place in the final product after unloading. This phenomenon is due to the action of internal stresses and is denoted by spring-back. So far it has been a challenge to compensate this phenomenon. In general, there are two points of view for compensating spring-back effect: 1) reducing and 2) excluding of spring-back [2].

The former is based on the fact that the amount of spring-back in deep drawn products can be reduced by properly taking into account the influence of addendum radii, draw bead, blank holder force and etc. However this strategy has shown to be effective, there still remains deviation after unloading. The latter point of view is considering forming the desired final product in the presence of spring-back by changing the tool shape [3, 4, 5]. In other words the tool shape can be modified in such a way that the desired product is achieved after occurrence of spring-back. By having this fact in mind one should improve the tool shape to achieve the desired product after unloading. Up to now several algorithms are developed based on this idea.

Among the available methods, the DA, displacement adjustment, and SF [6,7], spring forward, methods are shown to be more effective [8]. SF method is limited to simple symmetric stamping processes. The DA method is simple in basis and its application is extended to more industrial products [9]. Whatever the strategy is, it is of interest to require less number of iterations for a good convergence due to the high cost of computation of nonlinear finite element

contact problems. A full review of spring-back prediction is beyond the scope of this paper, but recent developments in these areas are cited more fully elsewhere [6, 7].

The objective of this paper is to develop a new spring-back compensation strategy relied on the spring-based demonstration of the deep drawn parts during stamping process. To accomplish the objective of this paper the following contributions are made.

The in plane deep drawing problem is simulated by ABAQUS. At the step that the blank is meshed, a nodal configuration is defined at the nodes in the middle of the thickness and is traced during loading and unloading. The nodal configurations at the blank, reference and spring-back meshes, extracted from FE results, accompanied by material properties are the inputs to the proposed strategy. The reference mesh is the one corresponding the configuration just before unloading and the spring-back mesh is the configuration after unloading. The relative displacements of neighbor nodes are described by mean of two springs. Tension springs account for stretching of each two neighbor nodes and torsion springs account for the angle between two lines connecting each three neighbor nodes. This definition implies that there are $n-1$ tension springs and $n-2$ torsion springs in the spring demonstration, n denotes the number of nodes in the nodal configuration. It is apparent that the mechanical behavior of these springs is neither elastic nor perfectly-plastic. The elastic-plastic behavior of each spring is predicted by the ideas of pure arc bending and pure stretching and is compensated by means of FE results. Evidently, in addition to material properties and blank thickness, there are some other parameters such as coefficient of friction, binder force etc that affect the stamping process and the amount of spring-back. To include the influence of these parameters, $n-2$

constants are introduced to the n-2 equations for torsion springs. Considering the blank, reference and spring-back meshes and solving for n-2 unknown c_i , the elastic-plastic behavior of each torsion spring is estimated. Now it is a routine task to predict the compensated reference mesh in order to have the desired final product after the occurrence of spring back.

Comparing the results of the proposed algorithm with those of the DA method reveals the efficiency and fast convergence of this strategy due to the less number of iterations required to a good convergence. The potential of this method is successfully demonstrated by two industrial parts used in truck mixer. The experimental results are in good agreement with the proposed ones.

In section 2 the basis of arc bending and the stretching are briefly discussed. The extension of these ideas to the compensation strategy is introduced in section 3. Section 4 provides the validation of the proposed strategy by comparing to DA method and experimental results

2. The basis of the proposed strategy

2.1 Arc bending

When a plate of thickness t under plane strain condition is loaded by the couple M , it forms an arc of radius R measuring at the middle of the thickness according to Fig. (1). The existence of elastic and plastic strains through the thickness under loaded condition causes the plate to deviate from its shape after unloading, say R' the radius after unloading.

Assuming plane strain condition, considering work hardening and neglecting the beuschionger effect, the unloaded radius is

estimated according to the following equation[2]:

$$\frac{1}{R} - \frac{1}{R'} = A \frac{1}{t} \left(\frac{t}{2R} \right)^n \quad (1)$$

Where:

$$A = k \left(\frac{1+r}{\sqrt{1+2r}} \right)^{1+n} \left(\frac{3(1-\nu^2)}{E(1+n)} \right)$$

2.1 Stretching

According to Fig. (2) when a bar of length L_1 is loaded to the length L_r , a total elongation $\delta = L_r - L_1$ takes place in the bar. when the bar is unloaded, it springs back and a plastic elongation $\xi = L_s - L_1$ remains in the bar. It is aimed to find the loaded length L_2 so that after unloading the plastic elongation $\delta = L_r - L_1$ remains in the bar. The relation between the total elongation and the plastic elongation is schematically shown in Fig. (3), where the following ratio is defined:

$$\frac{L_2 - L_1}{L_s - L_1} = \frac{L_r - L_1}{L_r - L_1} \quad (2)$$

Thus the compensated length L_2 is found as follows:

$$L_2 = \frac{\delta^2}{\xi} + L_1 \quad (3)$$

3. Spring-back compensation

Consider a plane strain U channel forming according to Fig. 4. The FE package, ABAQUS, has been implemented to simulate the stamping process. The required steps to define a proper simulation are listed below [9]:

- Modeling the die, punch, blank holder and blank in a CAD package and importing them to the FE package.

- Defining the material properties, table1. The punch, the die and the blank holder are considered rigid bodies.
- Defining the simulation steps
- Meshing the blank
- When the blank is meshed, a nodal configuration is defined at the mid plane of the thickness.
- Starting the simulation

Along with running the stamping process in ABAQUS, the defined nodal configuration is traced. The nodal configuration at the three stages: 1) blank, 2) reference and 3) spring-back are key inputs to the proposed strategy. Based on these nodal configurations, the spring-based demonstration of the part at these three stages is sketched in Fig. 5.

Three arbitrary neighbor nodes are selected from the blank nodal configuration. The positions of these nodes are traced in the blank, reference and spring-back meshes. Fig.(6) depicts the spring-based demonstration of these nodes, the lengths of the two connecting bars and the corresponding angles between them in the blank, reference and spring-back nodal configuration.

As seen from Fig.(6) both L_{ij} and $\theta_{,i}$ blank, reference and spring-back nodal configuration and $j=1,2$ vary during stamping process. For these nodes, L_{ij} and θ for different stages are extracted from FE results and are shown in table 1. It is intended to estimate the compensated bar lengths (L_{cj} , c=compensated) and the corresponding compensated angle θ_c for these three nodes. The compensated tool is more sensitive to θ_c compared with L_{cj} . Following the Eq.(2), estimating of L_{cj} is straight forward. The key point in the compensation strategy is to properly assess θ_c .

At node i , ($i=1$ to $(n-2)$), i represent an inner node), it is required to find θ_c^i by having the

values of θ_r^i , θ_s^i and L_{cj}^i (Fig. (7)).

Considering these three nodes in the reference and spring-back meshes, one can fit two arcs with radii R_r and R_s in the reference and spring-back meshes respectively. According to Fig. (8) the radius of the arc in the reference mesh is calculated as follows:

$$\cos\left(\frac{\theta_r}{2}\right) = \frac{L_r}{2R_r} \Rightarrow R_r = \frac{L_r}{2\cos\left(\frac{\theta_r}{2}\right)} \quad (4)$$

For the sake of simplicity it is assumed that L_{r1} and L_{r2} are replaced by $L_r = (L_{r1}+L_{r2})/2$. Upon unloading, the spring-back radius R' is found:

$$R_s = \frac{L_s}{2\cos\left(\frac{\theta_s}{2}\right)} \quad (5)$$

The spring-back radius, R_s , is a function of reference radius, R_r , material properties, blank thickness, binder force and coefficient of friction. This dependence can be expressed as:

$$R' = f(R, k, n, r, t, F_{blankholder}, \mu) \quad (6)$$

Or:

$$R' = g(R, k, n, r, t)h(F_{blankholder}, \mu) \quad (7)$$

Under the condition in which no friction and binder force exist, the radii R and R' satisfy the Eq.(1). Substituting Eqs.(4) and (5) into Eq.(1) yields:

$$\cos(\theta_r/2) - \cos(\theta_s/2) = A \times \frac{1}{2} \times (t/L)^{n-1} \times (\cos(\theta_r/2))^n \quad (8)$$

The above equation correlates the angle between the connecting bars in the reference and spring-back meshes. This equation states that if two collinear lines are deformed in such a way that the constitute angle between them becomes θ_r , after unloading this angle changes

to θ_s . From the first FE run, values of the three first rows of the table 1 are extracted for (n-2) torsion springs and (n-1) tension springs. Fig. (9) depicts the angle between the connecting bars in both reference and spring-back meshes for the example shown in Fig.(9). In reality due to influence of several parameters the angles θ_r^i and θ_s^i , ($i=1,2, \dots, (n-2)$), in the reference and spring-back meshes don't satisfy equation 8. To include the effect of these parameters and to compensate the equation representing the elastic-plastic behavior of each torsion spring, (n-2) constants c^i ($i = 1: (n-2)$) are introduced into Eq.(8):

$$\cos(\theta_r/2) - \cos(\theta_s/2) = A \times \frac{c}{2} \times (t/L)^{n-1} \times (\cos(\theta_r/2))^n \quad (9)$$

According to Fig.(7) the reference and spring-back angles at the node i are θ_r^i and θ_s^i respectively. Now it is required to find the compensated angle θ_c^i in which after unloading the desired angle θ_r^i is achieved. Substituting θ_r^i and θ_s^i into Eq.(9), the compensation parameter c^i is found as follows:

$$c_i = 2(\cos(\theta_{ri}/2) - \cos(\theta_{si}/2)) / (A \times (t/L)^{n-1} \times (\cos(\theta_{ri}/2))^n) \quad (10)$$

For node i , it is required to have the spring-back angle θ_r^i . If in Eq.(9), θ_s and c be substituted by θ_{si} and c_i respectively then the reference angle θ_r which denotes the compensated angle θ_c^i is found. Repeating the above algorithm for all inner nodes the compensated angles θ_c^i , ($i=1,2, \dots, (n-2)$) are found.

By finding the compensated angles and lengths, a cloud of points, representing the compensation geometry for the first iteration is found. The root mean square shape error for the first iteration is implemented as the comparison factor between the DA and the

proposed strategies. The error function is calculated as:

$$error_j = \sqrt{\frac{\sum d_i^2}{n}} \quad (11)$$

Where d_i , represents deviation at node i and j is the iteration number.

For the sake of comparison, the example introduced in section 3 is compensated by means of the DA and proposed methods, Fig. (10). Table 2 includes the RMSE of the two methods. It is inferred that the convergence of the proposed method is better than the DA method.

The rate of convergence of the spring-back mesh based on the proposed method is depicted in Fig. 11. It is deduced that at third iteration a very satisfactory convergence is achieved.

For the sake of assessment, an arbitrary drawn part shown in Fig.(12) is examined by the proposed method. The results from Fig.(13) and Table (3) prove the fast convergence of the proposed algorithm.

4. Experiments

Shoot and Shalvarak are parts of a truck mixer used for concrete discharging made of a nonabrasive St50 material with 4 mm in thickness, Fig. 14. This kind of blank suffers from spring-back phenomenon and a large deviation is taken place in the final part after unloading.

To ease the manufacturing process, it was aimed not to use blank holder force. Fig 15 depicts the geometry of the desired shoot. Firstly setting the tool geometry to the desired one, the FE simulation is carried out.

The result of the first iteration of stamping

process is shown in Fig. 16. Accordingly by having the reference and spring-back meshes extracted from the FE results, the compensation strategy is conducted. It was shown that at the 3rd iteration the required convergence is achieved. Experimental setup based on the compensation tool geometry is carried out and final product is shown in Fig.(17). The comparison between the final and desired geometries reveals that the deviation is within the tolerable tolerance. The same algorithm is adopted for manufacturing of the Shalvarak. The final product is shown in Fig.(18).

5. Conclusion

The objective of this paper was to introduce a new strategy for compensating spring-back in sheet metal working. Adopting the spring-based demonstration, the effects of parameters such as blank holder force, friction and etc are taken into account by introducing a constant to the elastic-plastic behavior of each torsion spring.

To assess the efficiency of the proposed algorithm, comparisons with the well known DA method have been made by means of some numerical examples. Also experiments are conducted for two industrial parts. The results from comparison with experimental data and DA method show that the proposed algorithm is fast and reliable. This algorithm has a promising potential for analysis of 3D parts and offers the possibility for manufacturing complicated industrial geometries.

Acknowledgements

The author wishes to express his thanks to Beton Machine Company for supplying the demonstration part and for continuous support during the project. Also extend thanks to Dr Assempour for his helpful discussions and contributions.

6. References

- [1].Kyung K. Choi and Nam H. Kim, Design Optimization of spring-back in a Deep drawing Process, AIAA JOURNAL , Vol. 40, No. 1, January 2002.
- [2].Haydar Livatyali, Gary L. Kinzel, Computer aided die design of straight flanging using approximate numerical analysis, Journal of Materials Processing Technology 142 (2003) 532–543.
- [3].R. Wagoner, Design of sheet forming dies for spring-back compensation, Proceedings of ESAFORM2003, Salerno, 2003, pp.7–14.
- [4].R. Wagoner, Fundamental aspects of spring-back in sheet metal forming, Proceedings of NUMISHEET2002, 2002, pp. 13–19.
- [5].R. Lingbeek, J. Weiher, The development of a finite elements based spring-back compensation tool for sheet metal products, Journal of Materials Processing Technology 169 (2005) 115–125.
- [6].Carden WD, Geng LM, Matlock DK, et al. Measurement of spring-back. International Journal of Mechanical Sciences 2002;44:79–101.
- [7].Li KP, Carden WP, Wagoner RH., Simulation of spring-back. International Journal of Mechanical Science 2002;44:103–22.
- [8].Nan Chou, Chinghua Hung, Finite element analysis and optimization on spring-back Reduction, International Journal of Machine Tools & Manufacture 39 (1999) 517–536.
- [9].Kyung K. Choi and Nam H. Kim, Design Optimization of Spring-back in a Deep drawing Process, AIAA JOURNAL , Vol. 40, No. 1, January 2002
- [10]. J. Weiher, B. Rietman, K. Kose, S. Ohnimus, M. Petzoldt, Controlling spring-

back with compensation strategies, in: NUMIFORM2004 Proceedings, Columbus, 2004, pp. 1011–1015.

- [11]. W.P. Carden, R.H. Wagoner, Simulation of spring-back, International Journal of Mechanical Sciences 44 (2002) 103–122
- [12]. Wei Gan, R.H. Wagoner, Die design method for sheet spring-back, International Journal of Mechanical Sciences 46 (2004) 1097–1113.

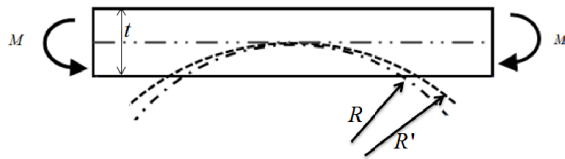

Fig.(10): Arc bending

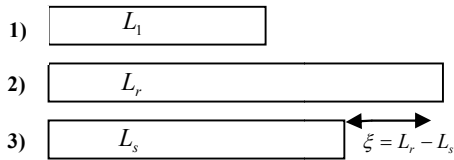

Fig.(2): Stretching

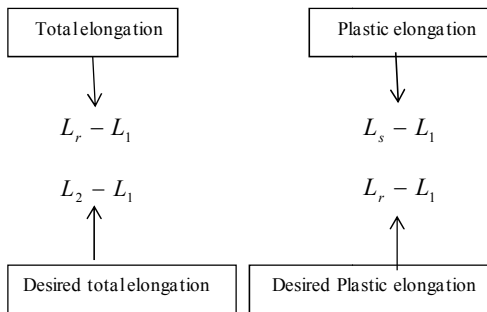

Fig.(3): Total and plastic elongation

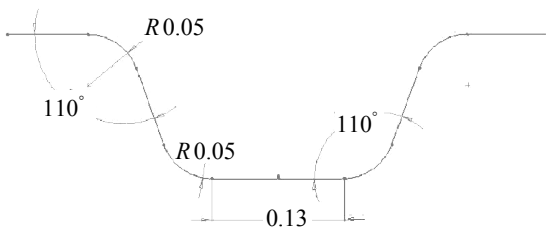

Fig.(4): Form of the desired final product

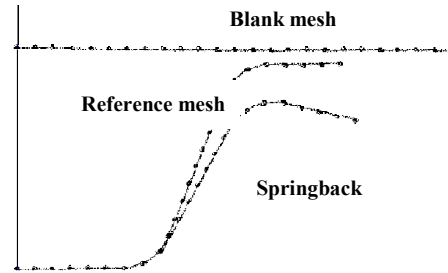

Fig.(5): The blank, reference and spring-back meshes in spring based demonstration

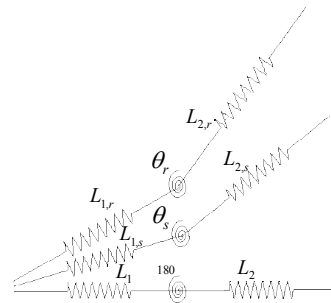

Fig.(6): Spring based demonstration of three neighbor nodes

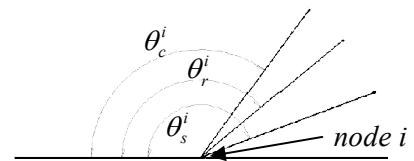

Fig. (7): Angle compensation

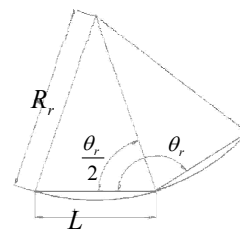

Fig.(8): Arc passing through three nodes

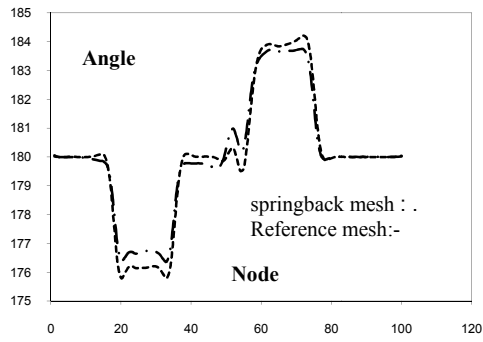

Fig.(9): Angle between connecting lines in both reference and spring-back meshes

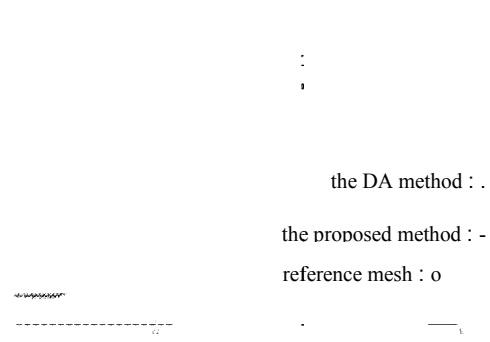

Fig.(10): Spring-back compensation for the first iteration

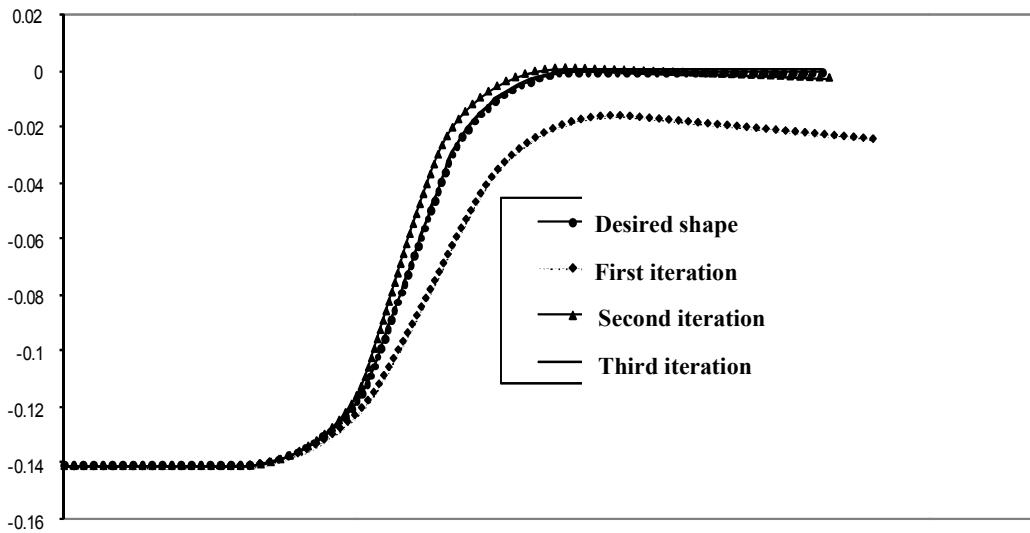

Fig.(11): Spring-back results of the proposed algorithm

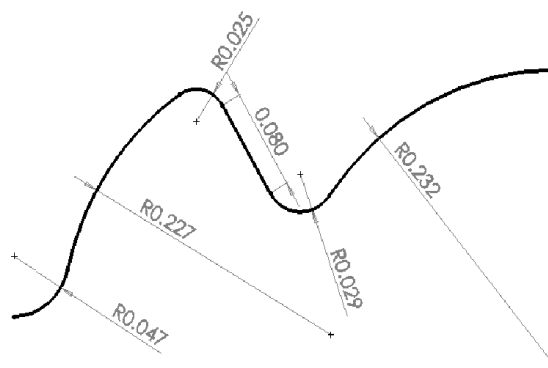

Fig. (12): An arbitrary complex 2D deep drawn parts

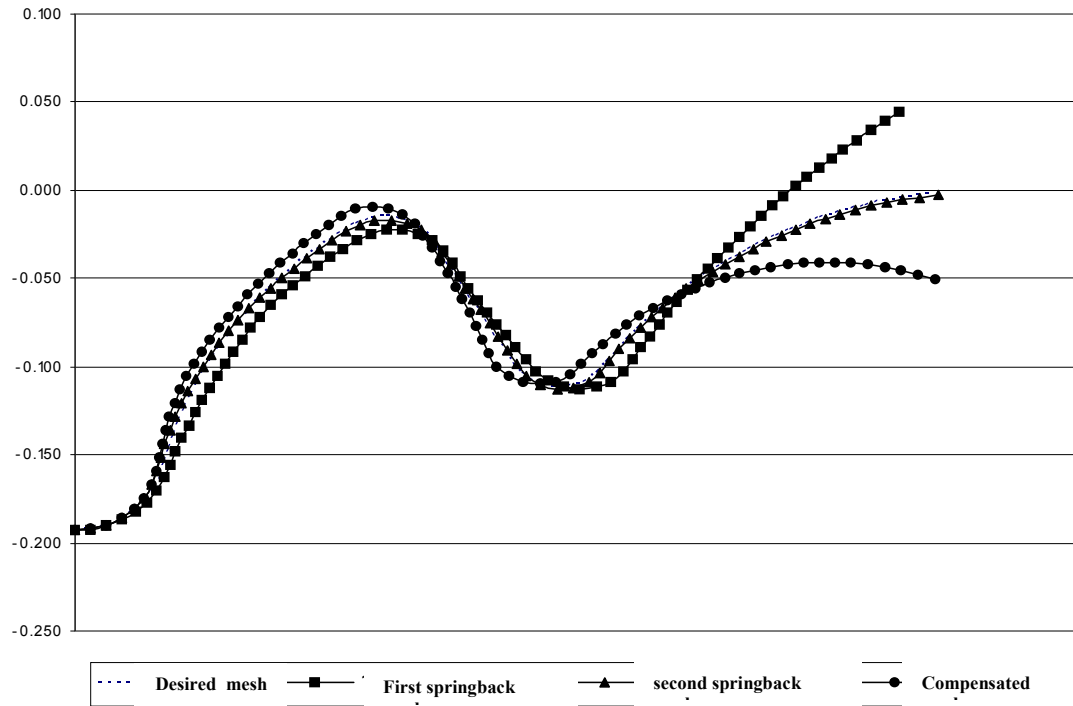

Fig. (13): Spring-back compensation of Fig. (12)



Fig. (14): Truck mixer.

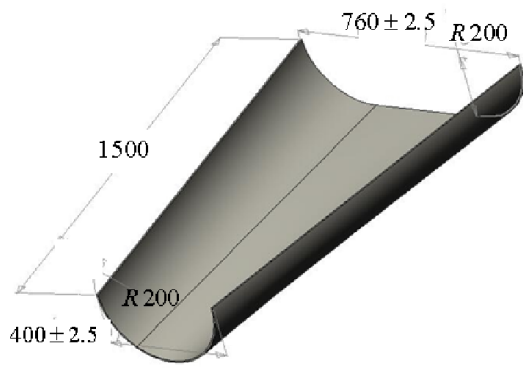

Fig. (15): Shoot with its desired dimension

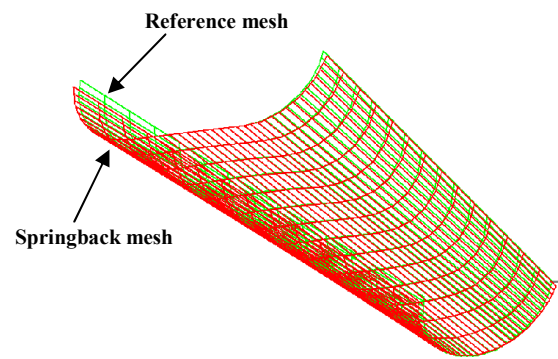

Fig. (16): The first iteration of stamping



Fig.(17): Fabricated shoot



Fig.(18): Fabricated Shalvarak

Table (1): L_{ij} and θ_i for different stages

mesh	Bar length 1	Bar length 2	θ
Blank	L_1	L_2	180
Reference	L_{r1}	L_{r2}	θ_r
Spring-back	L_{s1}	L_{s2}	θ_s
Compensated	L_{c1}	L_{c2}	θ_c

Table(3): RMSE for Fig.(12)

iteration	RMSE
1	0.0153
2	0.00123

Table(2): RMSE for to first iterations

iteration	DA method	proposed method
1	0.016	0.016
2	0.013	0.0107

